



# FEMALE JIC ULTRA-CRIMP HYDRAULIC FITTING

This family of fittings is designed for 100R1, 100R2, and 100R16.

NUMBER	DESCRIPTION
40-2025	B2-JCFX-0404 1/4" x 1/4" FJIC
40-2026	B2-JCFX-0405 1/4" x 5/16" FJIC
40-2024	B2-JCFX-0406 1/4" x 3/8" FJIC
40-2028	B2-JCFX-0606 3/8" x 3/8" FJIC
40-2029	B2-JCFX-0608 3/8" x 1/2" FJIC
40-2014	B2-JCFX-0808 1/2" x 1/2" FJIC
40-2027	B2-JCFX-0810 1/2" x 5/8" FJIC
40-2003	B2-JCFX-0812 1/2" x 3/4" FJIC
40-2012	B2-JCFX-1010 5/8" x 5/8" FJIC
40-2021	B2-JCFX-1012 5/8" x 3/4" FJIC
40-2020	B2-JCFX-1212 3/4" x 3/4" FJIC
40-2357	B2-JCFX-1216 3/4" x 1" FJIC



40-2002	B2-JCFX-1616 1" x 1" FJIC
40-2358	B2-JCFX-1620 1" x 1-1/4" FJIC
40-2001	S4-JCFX-2020 1-1/4" x 1-1/4" FJIC
40-2004	S4-JCFX-2424 1-1/2" x 1-1/2" FJIC
40-2023	S4-JCFX-3232 2" x 2" FJIC

Available in steel and stainless steel.

## FEMALE 45° JIC ULTRA-CRIMP HYDRAULIC FITTING

This family of fittings is designed for 100R1, 100R2, and 100R16.

NUMBER	DESCRIPTION
40-2037	B2-JCFX45-0404 – 1/4" x 1/4" 45° FJIC
40-2038	B2-JCFX45-0405 – 1/4" x 5/16" 45° FJIC
40-2039	B2-JCFX45-0406 – 1/4" x 3/8" 45° FJIC
40-2040	B2-JCFX45-0606 – 3/8" x 3/8" 45° FJIC
40-2041	B2-JCFX45-0608 – 3/8" x 1/2" 45° FJIC
40-2042	B2-JCFX45-0808 – 1/2" x 1/2" 45° FJIC
40-2043	B2-JCFX45-0810 – 1/2" x 5/8" 45° FJIC
40-2044	B2-JCFX45-1010 – 5/8" x 5/8" 45° FJIC
40-2045	B2-JCFX45-1012 – 5/8" x 3/4" 45° FJIC
40-2046	B2-JCFX45-1212 – 3/4" x 3/4" 45° FJIC



40-2047	B2-JCFX45-1216 – 3/4" x 1" 45° FJIC
40-2048	B2-JCFX45-1612 – 1" x 3/4" 45° FJIC
40-2049	B2-JCFX45-1616 – 1" x 1" 45° FJIC
40-2050	S4-JCFX45-2020 – 1-1/4" x 1-1/4" 45° FJIC
40-2051	S4-JCFX45-2424 – 1-1/2" x 1-1/2" 45° FJIC

Available in steel and stainless steel through 2".

# FEMALE 90° JIC ULTRA-CRIMP HYDRAULIC FITTING

This family of fittings is designed for 100R1, 100R2, and 100R16.

NUMBER	DESCRIPTION
40-2052	B2-JCFX90-0404 – 1/4" x 1/4" 90° FJIC
40-2053	B2-JCFX90L-0404 – 1/4" x 1/4" 90° FJIC
40-2054	B2-JCFX90-0405 – 1/4" x 5/16" 90° FJIC
40-2055	B2-JCFX90L-0405 – 1/4" x 5/16" 90° Long FJIC
40-2056	B2-JCFX90-0406 – 1/4" x 3/8" 90° FJIC
40-2057	B2-JCFX90L-0406 – 1/4" x 3/8" 90° Long FJIC
40-2058	B2-JCFX90-0604 – 3/8" x 1/4" 90° FJIC
40-2059	B2-JCFX90-0606 – 3/8" x 3/8" 90° FJIC
40-2060	B2-JCFX90L-0606 – 3/8" x 3/8" 90° Long FJIC
40-2061	B2-JCFX90-0608 – 3/8" x 1/2" 90° FJIC



40-2062	B2-JCFX90-0808 – 1/2" x 1/2" 90° FJIC
40-2293	B2-JCFX90L-0808 – 1/2" x 1/2" 90 Long FJIC
40-2063	B2-JCFX90-0810 – 1/2" x 5/8" 90° FJIC
40-2064	B2-JCFX90-0812 – 1/2" x 3/4" 90° FJIC
40-2065	B2-JCFX90-1012 – 5/8" x 3/4" 90° FJIC
40-2066	B2-JCFX90-1012 – 5/8" x 3/4" 90° FJIC
40-2067	B2-JCFX90-1212 – 3/4" x 3/4" 90° FJIC
40-2068	B2-JCFX90-1216 – 3/4" x 1" 90° FJIC
40-2069	B2-JCFX90-1616 – 1" x 1" 90° FJIC
40-2070	S4-JCFX90-2020 – 1-1/4" x 1-1/4" 90° FJIC
40-2071	S4-JCFX90-2424 – 1-1/2" x 1-1/2" 90° FJIC

Available in steel and stainless steel through 2".

## MALE JIC ULTRA-CRIMP HYDRAULIC FITTING

This family of fittings is designed for 100R1, 100R2, 100R16, and Jack Hose.

NUMBER	DESCRIPTION
40-2005	B2-JCM-0404 – 1/4" x 1/4" MJIC
40-2006	B2-JCM-0405 – 1/4" x 5/16" MJIC
40-2009	B2-JCM-0406 – 1/4" x 3/8" MJIC
40-2017	B2-JCM-0606 – 3/8" x 3/8" MJIC



40-2013	B2-JCM-0608 – 3/8" x 1/2" MJIC
40-2008	B2-JCM-0808 – 1/2" x 1/2" MJIC
40-2007	B2-JCM-0810 – 1/2" x 5/8" MJIC
40-2015	B2-JCM-1010 – 5/8" x 5/8" MJIC
40-2016	B2-JCM-1012 – 5/8" x 3/4" MJIC
40-2018	B2-JCM-1212 – 3/4" x 3/4" MJIC
40-2011	B2-JCM-1616 – 1" x 1" MJIC
40-2010	S4-JCM-2020 – 1-1/4" x 1-1/4" MJIC
40-2022	S4-JCM-2424 – 1-1/2" x 1-1/2" MJIC
40-2019	S4-JCM-3232 – 2" x 2" MJIC

Available in steel and stainless steel through 2".

## FEMALE JIC 4 WIRE ULTRA-CRIMP HYDRAULIC FITTING

This family of fittings is designed for 4 wire hoses such as 100R12 and DIN.

NUMBER	DESCRIPTION
40-2218	S6-JCFX-0808 – 1/2" x 1/2" FJIC
40-2223	S6-JCFX-0810 – 1/2" x 5/8" FJIC
40-2236	S6-JCFX-1212 – 3/4" x 3/4" FJIC
40-2235	S6-JCFX-1616 – 1" x 1" FJIC
40-2240	S6-JCFX-2020 – 1-1/4" x 1-1/4" FJIC



40-2234	S6-JCFX-2424 – 1-1/2" x 1-1/2" FJIC	
40-2360	S6-JCFX-3232 – 2" x 2" FJIC	

Available in steel and stainless steel.

## FEMALE 45° JIC 4-WIRE ULTRA-CRIMP HYDRAULIC FITTING

This family of fittings is designed for 4 wire hoses such as 100R12 and DIN.

NUMBER	DESCRIPTION	
40-2219	S6-JCFX45-0808 – 1/2" x 1/2" 45° FJIC	
40-3219	S6-JCFX45-0810 – 1/2" x 5/8" 45° FJIC	
40-3220	S6-JCFX45-1212 – 3/4" x 3/4" 45° FJIC	
40-3221	S6-JCFX45-1216 – 3/4" x 1" 45° FJIC	
40-3222	S6-JCFX45-1612 – 1" x 3/4" 45° FJIC	
40-3223	S6-JCFX45-1616 – 1" x 1" 45° FJIC	
40-3224	S6-JCFX45-2020 – 1-1/4" x 1-1/4" 45° FJIC	
40-3225	S6-JCFX45-2424 – 1-1/2" x 1-1/2" 45° FJIC	

Available in steel and stainless steel through 2".

## FEMALE 90° JIC 4 WIRE ULTRA-CRIMP HYDRAULIC FITTING

This family of fittings is designed for 100R12 and DIN Hydraulic Hose.

NUMBER	DESCRIPTION
40-2217	S6-JCFX90-0808 – 1/2" x 1/2" 900 FJIC
40-2220	S6-JCFX90L-0808 – 1/2" x 1/2" 90 Long FJIC
40-3227	S6-JCFX90-0810 – 1/2" x 5/8" 900 FJIC
40-3228	S6-JCFX90-1010 – 5/8" x 5/8" 900 FJIC
40-2237	S6-JCFX90-1212 – 3/4" x 3/4" 900 FJIC
40-2232	S6-JCFX90-1616 – 1" x 1" 900 FJIC
40-2233	S6-JCFX90-2020 – 1-1/4" x 1-1/4" 900 FJIC
40-2238	S6-JCFX90-2424 – 1-1/2" x 1-1/2" 900 FJIC



Available in steel and stainless steel through 2".

## MALE JIC 4 WIRE ULTRA-CRIMP HYDRAULIC FITTING

This family of fittings is designed for 100R12 and DIN Hydraulic Hose.

NUMBER	DESCRIPTION
40-2222	S6-JCM-0808 – 1/2" x 1/2" MJIC
40-2221	S6-JCM-0810 – 1/2" x 5/8" MJIC
40-3230	S6-JCM-1010 – 5/8" x 5/8" MJIC
40-3231	S6-JCM-1212 – 3/4" x 3/4" MJIC



40-3232	S6-JCM-1616 – 1" x 1" MJIC
40-3233	S6-JCM-2020 – 1-1/4" x 1-1/4" MJIC
40-3234	S6-JCM-2424 – 1-1/2" x 1-1/2" MJIC
40-3235	S6-JCM-3232 – 2" x 2" MJIC

Available in steel and stainless steel through 2".

## FEMALE FLAT FACE ULTRA-CRIMP HYDRAULIC FITTING

This family of fittings is designed for 100R1, 100R2, and 100R16.

NUMBER	DESCRIPTION
40-2292	B2-OFFX-0404 – 1/4" x 1/4" Fem Flat Face
40-2084	B2-OFFX-0606 – 3/8" x 3/8" Fem Flat Face
40-2289	B2-OFFX-0608 – 3/8" x 1/2" Fem Flat Face
40-2085	B2-OFFX-0808 – 1/2" x 1/2" Fem Flat Face
40-2286	B2-OFFX-0810 – 1/2" x 5/8" Fem Flat Face
40-2285	B2-OFFX-0812 – 1/2" x 3/4" Fem Flat Face
40-2086	B2-OFFX-1010 – 5/8" x 5/8" Fem Flat Face
40-2290	B2-OFFX-1012 – 5/8" x 3/4" Fem Flat Face
40-2087	B2-OFFX-1212 – 3/4" x 3/4" Fem Flat Face
40-2291	B2-OFFX-1216 – 3/4" x 1" Fem Flat Face
40-2088	B2-OFFX-1616 – 1" x 1" Fem Flat Face





Available in steel and stainless steel through 1-1/2".

# FEMALE FLAT FACE ULTRA-CRIMP 45° HYDRAULIC FITTING

This family of fittings is designed for 100R1, 100R2, and 100R16.

NUMBER	DESCRIPTION	
40-2089	B2-OFFX45-0404 – 1/4" x 1/4" Fem Flat Face 45°	
40-2090	B2-OFFX90-0606 – 3/8" x 3/8" Fem Flat Face 45°	
40-2091	B2-OFFX90-0808 – 1/2" x 1/2" Fem Flat Face 45°	
40-2092	B2-OFFX90-1010 – 5/8" x 5/8" Fem Flat Face 45°	
40-2093	B2-OFFX90-1212 – 3/4" x 3/4" Fem Flat Face 45°	
40-2094	B2-OFFX90-1616 – 1" x 1" Fem Flat Face 45°	

Available in steel and stainless steel through 1-1/2".

# FEMALE FLAT FACE ULTRA-CRIMP 90° HYDRAULIC FITTING

This family of fittings is designed for 100R1, 100R2, and 100R16.

NUMBER	DESCRIPTION	
40-2095	B2-OFFX90-0404 – 1/4" x 1/4" Fem Flat Face 90°	

40-2096	B2-OFFX90-0606 – 3/8" x 3/8" Fem Flat Face 90°
40-2097	B2-OFFX90-0808 – 1/2" x 1/2" Fem Flat Face 90°
40-2098	B2-OFFX90-1010 – 5/8" x 5/8" Fem Flat Face 90°
40-2099	B2-OFFX90-1212 – 3/4" x 3/4" Fem Flat Face 90°
40-2100	B2-OFFX90-1616 – 1" x 1" Fem Flat Face 90°



Available in steel and stainless steel through 1-1/2".

# MALE FLAT FACE ULTRA-CRIMP HYDRAULIC FITTING

This family of fittings is designed for 100R1, 100R2, and 100R16.

NUMBER	DESCRIPTION
40-2101	B2-OFM-0404 – 1/4" x 1/4" Male Flat Face
40-2102	B2-OFM-0606 – 3/8" x 3/8" Male Flat Face
40-2103	B2-OFM-0808 – 1/2" x 1/2" Male Flat Face
40-2288	B2-OFM-0810 – 1/2" x 5/8" Male Flat Face
40-2287	B2-OFM-0812 – 1/2" x 3/4" Male Flat Face
40-2104	B2-OFM-1010 – 5/8" x 5/8" Male Flat Face
40-2105	B2-OFM-1212 – 3/4" x 3/4" Male Flat Face
40-2106	B2-OFM-1616 – 1" x 1" Male Flat Face



Available in steel and stainless steel through 1-1/4".

# FEMALE FLAT FACE 4 WIRE ULTRA-CRIMP HYDRAULIC FITTING

This family of fittings is designed for 100R12 and DIN Hydraulic Hose.

NUMBER	DESCRIPTION	
40-2226	S6-OFFX-0808 – 1/2" x 1/2" Fem Flat Face	
40-2225	S6-OFFX-0810 – 1/2" x 5/8" Fem Flat Face	
40-3237	S6-OFFX-0812 – 1/2" x 3/4" Fem Flat Face	
40-3238	S6-OFFX-1010 – 5/8" x 5/8" Fem Flat Face	
40-3239	S6-OFFX-1012 – 5/8" x 3/4" Fem Flat Face	
40-3240	S6-OFFX-1212 – 3/4" x 3/4" Fem Flat Face	
40-3241	S6-OFFX-1216 – 3/4" x 1" Fem Flat Face	
40-3242	S6-OFFX-1616 – 1" x 1" Fem Flat Face	

Available in steel and stainless steel through 1-1/2".

# FEMALE FLAT FACE 4 WIRE ULTRA-CRIMP 90° HYDRAULIC FITTING

This family of fittings is designed for 100R12 and DIN Hydraulic Hose.

NUMBER	DESCRIPTION	
40-2239	S6-OFFX90-0808 – 1/2" x 1/2" Fem Flat Face 90°	

40-3247	S6-OFFX90-1010 – 5/8" x 5/8" Fem Flat Face 90°
40-3248	S6-OFFX90-1212 – 3/4" x 3/4" Fem Flat Face 90°
40-3249	S6-OFFX90-1616 – 1" x 1" Fem Flat Face 90°



Available in steel and stainless steel through 1-1/2".

## MALE FLAT FACE 4 WIRE ULTRA-CRIMP HYDRAULIC FITTING

This family of fittings is designed for 100R12 and DIN Hydraulic Hose.

NUMBER	DESCRIPTION
40-2227	S6-OFM-0808 – 1/2" x 1/2" Male Flat Face
40-3226	S6-OFM-0810 – 1/2" x 5/8" Male Flat Face
40-3243	S6-OFM-0812 – 1/2" x 3/4" Male Flat Face
40-3244	S6-OFM-1010 – 5/8" x 5/8" Male Flat Face
40-3245	S6-OFM-1212 – 3/4" x 3/4" Male Flat Face
40-3246	S6-OFM-1616 – 1" x 1" Male Flat Face



Available in steel and stainless steel through 1-1/4".

## FEMALE NPT ULTRA-CRIMP HYDRAULIC SWIVEL FITTING

This family of fittings is designed for 100R1, 100R2, and 100R16.

NUMBER	DESCRIPTION
40-2030	B2-NSMX-0404 – 1/4" x 1/4" FNPT Swivel
40-2031	B2-NSMX-0606 – 3/8" x 3/8" FNPT Swivel



Available in steel and stainless steel up to 1-1/4".

## FEMALE NPT ULTRA-CRIMP HYDRAULIC RIGID FITTING

This family of fittings is designed for 100R1, 100R2, and 100R16.

NUMBER	DESCRIPTION
40-2076	B2-NPF-0404 – 1/4" x 1/4" FNPT Rigid
40-2077	B2-NPF-0604 – 3/8" x 1/4" FNPT Rigid
40-2078	B2-NPF-0606 – 3/8" x 3/8" FNPT Rigid
40-2298	B2-NPF-0808 – 1/2" x 1/2" FNPT Rigid



Available in steel and stainless steel up to 3/4".

## MALE NPT ULTRA-CRIMP HYDRAULIC SWIVEL FITTING

This family of fittings is designed for 100R1, 100R2, and 100R16.

NUMBER	DESCRIPTION
40-2079	B2-NPMX-0404 – 1/4" x 1/4" MNPT Swivel
40-2080	B2-NPMX-0604 – 3/8" x 1/4" MNPT Swivel
40-2081	B2-NPMX-0606 – 3/8" x 3/8" MNPT Swivel
40-2082	B2-NPMX-0808 – 1/2" x 1/2" MNPT Swivel
40-2083	B2-NPMX-1212 – 3/4" x 3/4" MNPT Swivel
40-2361	B2-NPMX-1616 – 1" x 1" MNPT Swivel



Available in steel and stainless steel.

## MALE NPT ULTRA-CRIMP HYDRAULIC FITTING

This family of fittings is designed for 100R1, 100R2, 100R16, and Jack Hose.

NUMBER	DESCRIPTION
40-2036	B2-NPM-0404 – 1/4" x 1/4" Male NPT
40-2035	B2-NPM-0406 – 1/4" x 3/8" Male NPT
40-2032	B2-NPM-0604 – 3/8" x 1/4" Male NPT
40-2033	B2-NPM-0606 – 3/8" x 3/8" Male NPT
40-2034	B2-NPM-0608 – 3/8" x 1/2" Male NPT
40-2248	B2-NPM-0806 – 1/2" x 3/8" Male NPT
40-2243	B2-NPM-0808 – 1/2" x 1/2" Male NPT



40-2242	B2-NPM-1212 – 3/4" x 3/4" Male NPT	
40-2247	B2-NPM-1612 – 1" x 3/4" Male NPT	
40-2244	B2-NPM-1616 – 1" x 1" Male NPT	

Available in steel and stainless steel up to 2".

## MALE NPT 4 WIRE ULTRA-CRIMP HYDRAULIC FITTING

This family of fittings is designed for 100R12 and DIN Hydraulic Hose.

NUMBER	DESCRIPTION	
40-2224	S6-NPM-0608 – 3/8" x 1/2" Male NPT	
40-2245	S6-NPM-0808 – 1/2" x 1/2" Male NPT	
40-3229	S6-NPM-1212 – 3/4" x 3/4" Male NPT	
40-3236	S6-NPM-1616 – 1" x 1" Male NPT	

Available in steel and stainless steel up to 2".

## FEMALE/MALE SAE 45° ULTRA-CRIMP HYDRAULIC FITTING

This family of fittings is designed for 100R1, 100R2, and 100R16.

NUMBER	DESCRIPTION
40-2072	B2-SFFX-0606 – 3/8" x 3/8" Fem SAE 45°
40-2073	B2-SFFX-1212 – 3/4" x 3/4" Fem SAE 45°

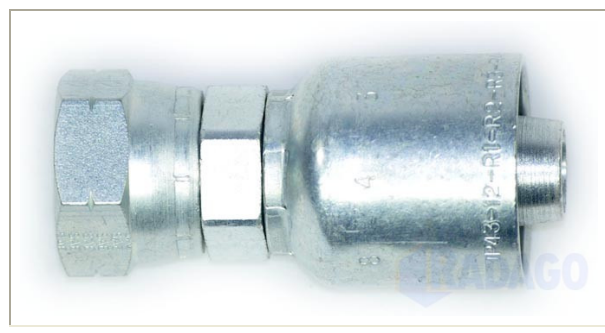

Available in steel and stainless steel.

NUMBER	DESCRIPTION
40-2074	B2-SFM-0606 – 3/8" x 3/8" Male SAE 45°
40-2075	B2-SFM-1212 – 3/4" x 3/4" Male SAE 45°



Available in steel and stainless steel.

## MALE O-RING BOSS ULTRA-CRIMP HYDRAULIC FITTING

This family of fittings is designed for 100R1, 100R2, 100R16, and Jack Hose.

NUMBER	DESCRIPTION
40-2107	B2-OBM-0606 – 3/8" x 3/8" Male O-Ring
40-2284	B2-OBM-0608 – 3/8" x 1/2" Male O-Ring
40-2108	B2-OBM-0808 – 1/2" x 1/2" Male O-Ring

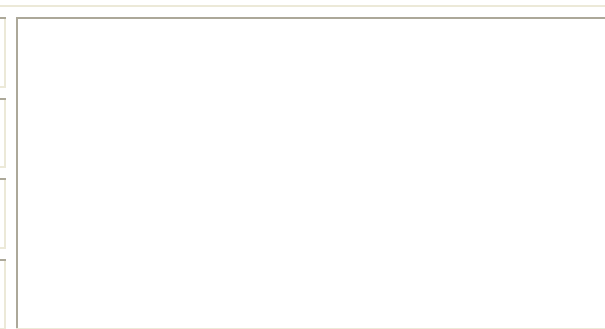



40-2109	B2-OBM-1010 – 5/8" x 5/8" Male O-Ring
40-2110	B2-OBM-1212 – 3/4" x 3/4" Male O-Ring



Available in steel and stainless steel through 1-1/4".

# FEMALE BSPP ULTRA-CRIMP HYDRAULIC FITTING

This family of fittings is designed for 100R1, 100R2, and 100R16

NUMBER	DESCRIPTION
40-2146	B2-BPFX-0404 1/4" x 1/4" Fem BSPP
40-2147	B2-BPFX-0406 1/4" x 3/8" Fem BSPP
40-2148	B2-BPFX-0606 3/8" x 3/8" Fem BSPP
40-2149	B2-BPFX-0808 1/2" x 1/2" Fem BSPP
40-2150	B2-BPFX-1010 5/8" x 5/8" Fem BSPP
40-2151	B2-BPFX-1212 3/4" x 3/4" Fem BSPP
40-2152	B2-BPFX-1616 1" x 1" Fem BSPP



Available in steel and stainless steel.

# FEMALE BSPP 45° ULTRA-CRIMP

## HYDRAULIC FITTING

This family of fittings is designed for 100R1, 100R2, and 100R16.

NUMBER	DESCRIPTION	
40-2153	B2-BPFX45-0404 – 1/4" x 1/4" 45° Fem BSPP	
40-2154	B2-BPFX45-0404 – 3/8" x 3/8" 45° Fem BSPP	
40-2155	B2-BPFX45-0404 – 1/2" x 1/2" 45° Fem BSPP	
40-2156	B2-BPFX45-0404 – 3/4" x 3/4" 45° Fem BSPP	

Available in steel and stainless steel.

# FEMALE BSPP 90° ULTRA-CRIMP

## HYDRAULIC FITTING

This family of fittings is designed for 100R1, 100R2, and 100R16

NUMBER	DESCRIPTION	
40-2157	B2-BPFX90-0404 – 1/4" x 1/4" 900 Fem BSPP	
40-2158	B2-BPFX90-0606 – 3/8" x 3/8" 900 Fem BSPP	
40-2159	B2-BPFX90-0608 – 3/8" x 1/2" 900 Fem BSPP	

40-2160	B2-BPFX90-0808 – 1/2" x 1/2" 900 Fem BSPP
40-2161	B2-BPFX90-1212 – 3/4" x 3/4" 900 Fem BSPP



Available in steel and stainless steel.

# MALE BSPP ULTRA-CRIMP HYDRAULIC FITTING

This family of fittings is designed for 100R1, 100R2, and 100R16.

NUMBER	DESCRIPTION
40-2162	B2-BPM-0404 – 1/4" x 1/4" Male BSPP
40-2163	B2-BPM-0606 – 3/8" x 3/8" Male BSPP
40-2164	B2-BPM-0608 – 3/8" x 1/2" Male BSPP
40-2166	B2-BPM-0806 – 1/2" x 3/8" Male BSPP
40-2165	B2-BPM-0808 – 1/2" x 1/2" Male BSPP
40-2167	B2-BPM-1010 – 5/8" x 5/8" Male BSPP
40-2168	B2-BPM-1212 – 3/4" x 3/4" Male BSPP
40-2169	B2-BPM-1616 – 1" x 1" Male BSPP



Available in steel and stainless steel.

# FEMALE JIS 30° ULTRA-CRIMP HYDRAULIC FITTING

This family of fittings is designed for 100R1, 100R2, and 100R16.

NUMBER	DESCRIPTION	
40-2142	B2-JSFX-0606 – 3/8" x 3/8" 30° JIS	
40-2143	B2-JSFX-0808 – 1/2" x 1/2" 30° JIS	
40-2144	B2-JCFX-1012 – 5/8" x 3/4" 30° JIS	
40-2145	B2-JCFX-1212 – 3/4" x 3/4" 30° JIS	

Available in steel and stainless steel.

# CODE 61 FLANGE ULTRA-CRIMP HYDRAULIC FITTING

This family of fittings is designed for 100R1, 100R2, and 100R16.

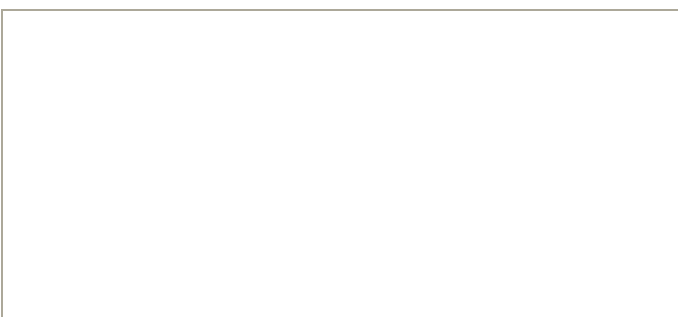
NUMBER	DESCRIPTION	
40-2111	B2-FL-1212 3/4" x 3/4" Code 61	
40-2112	B2-FL-1212 3/4" x 1" Code 61	
40-2113	B2-FL-1616 1" x 1" Code 61	

40-2114	B2-FL-1620 1" x 1-1/4" Code 61
40-2115	S4-FL-2020 1-1/4" x 1-1/4" Code 61
40-2116	S4-FL-2024 1-1/4" x 1-1/2" Code 61
40-2117	S4-FL-2424 1-1/2" x 1-1/2" Code 61
40-2118	S4-FL-2432 1-1/2" x 2" Code 61
40-2118	S4-FL-3232 2" x 2" Code 61



Available in steel and stainless steel.

## CODE 61 90° FLANGE ULTRA-CRIMP HYDRAULIC FITTING

This family of fittings is designed for 100R1, 100R2, and 100R16.

NUMBER	DESCRIPTION
40-2120	B2-FL90-1616 1" x 1" Code 61 90°
40-2121	B2-FL90-16020 1" x 1-1/4" Code 61 90°
40-2122	S4-FL90-2020 1-1/4" x 1-1/4" Code 61 90°
40-2123	S4-FL90-2024 1-1/4" x 1-1/2" Code 61 90°
40-2124	S4-FL90-2424 1-1/2" x 1-1/2" Code 61 90°
40-2125	S4-FL90-3232 2" x 2" Code 61 90°



Available in steel and stainless steel.

# CODE 62 FLANGE ULTRA-CRIMP HYDRAULIC FITTING

This family of fittings is designed for 100R1, 100R2, and 100R16.

NUMBER	DESCRIPTION
40-2126	B2-FH-1212 3/4" x 3/4" Code 62
40-2127	B2-FH-1616 1" x 1" Code 62
40-2128	B2-FH-1620 1" x 1-1/4" Code 62
40-2129	S4-FH-2020 1-1/4" x 1-1/4" Code 62
40-2130	S4-FH-2024 1-1/4" x 1-1/2" Code 62
40-2131	S4-FH-2424 1-1/2" x 1-1/2" Code 62
40-2132	S4-FH-2432 1-1/2" x 2" Code 62
40-2133	S4-FH-3232 2" x 2" Code 62



Available in steel and stainless steel through 2".

# CODE 62 90° FLANGE ULTRA-CRIMP HYDRAULIC FITTING

This family of fittings is designed for 100R1, 100R2, and 100R16.

NUMBER	DESCRIPTION	
40-2134	B2-FH90-1212 3/4" x 3/4" Code 62 90°	

40-2136	B2-FH90-1616 1" x 1" Code 62 90°
40-2135	B2-FH90-16020 1" x 1-1/4" Code 62 90°
40-2137	S4-FH90-2020 1-1/4" x 1-1/4" Code 62 90°
40-2138	S4-FH90-2024 1-1/4" x 1-1/2" Code 62 90°
40-2139	S4-FH90-2424 1-1/2" x 1-1/2" Code 62 90°
40-2140	S4-FH90-2432 1-1/2" x 2" Code 62 90°
40-2141	S4-FH90-3232 2" x 2" Code 62 90°



Available in steel and stainless steel through 2".

## FEMALE JIC UNI-CRIMP HYDRAULIC FITTING

This family of fittings is designed for 100R4, 100R3, and 100R6.

NUMBER	DESCRIPTION
40-2184	UC-JCFX-1212 – 3/4" x 3/4" FJIC
40-2185	UC-JCFX-1616 – 1" x 1" FJIC
40-2183	UC-JCFX-2020 – 1-1/4" x 1-1/4" FJIC
40-2179	UC-JCFX-2424 – 1-1/2" x 1-1/2" FJIC
40-2178	UC-JCFX-3232 – 2" x 2" FJIC



Available in steel and stainless steel.

# MALE NPT UNI-CRIMP HYDRAULIC FITTING

This family of fittings is designed for 100R4, 100R3, and 100R6.

NUMBER	DESCRIPTION
40-2181	UC-NPM-1212 – 3/4" x 3/4" Male NPT
40-2180	UC-NPM-1616 – 1" x 1" Male NPT
40-2182	UC-NPM-2020 – 1-1/4" x 1-1/4" Male NPT
40-2177	UC-NPM-2424 – 1-1/2" x 1-1/2" Male NPT
40-2176	UC-NPM-3232 – 2" x 2" Male NPT

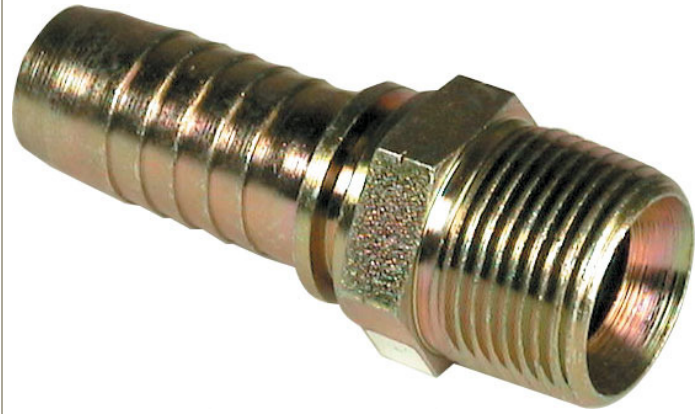

Available in steel and stainless steel.

# FERRULES FOR UNI-CRIMP HYDRAULIC FITTING

This family of fittings is designed for 100R4, 100R3, and 100R6.

NUMBER	DESCRIPTION
40-2296	UCF6-06 – 3/8" Ferrule
40-2297	UCF6-08 – 1/2" Ferrule
40-2231	UCF6-12 – 3/4" Ferrule
40-2175	UCF6-16 – 1" Ferrule
40-2230	UCF6-20 – 1-1/4" Ferrule



40-2229	UCF6-24 – 1-1/2" Ferrule
40-2228	UCF6-32 – 2" Ferrule



Available in steel and stainless steel.

## FEMALE JIC RE-USEABLE HYDRAULIC FITTING

This family of fittings is designed for 100R5 Hydraulic Hose.

NUMBER	DESCRIPTION
40-2266	FG-JCFX-0404 3/16" x 1/4" FJIC
40-2267	FG-JCFX-0505 1/4" x 5/16" FJIC
40-2268	FG-JCFX-0606 5/16" x 3/8" FJIC
40-2269	FG-JCFX-0808 13/32" x 1/2" FJIC
40-2270	FG-JCFX-1010 1/2" x 5/8" FJIC
40-2271	FG-JCFX-1212 5/8" x 3/4" FJIC
40-2272	FG-JCFX-1616 7/8" x 1" FJIC



Available in steel and stainless steel through 2".

# MALE MNPT REUSEABLE HYDRAULIC FITTING

This family of fittings is designed for 100R5 Hydraulic Hose.

NUMBER	DESCRIPTION
40-2275	FG-NPM-0404 3/16" x 1/4" MNPT
40-2276	FG-NPM-0504 1/4" x 1/4" MNPT
40-2277	FG-NPM-0604 5/16" x 1/4" MNPT
40-2278	FG-NPM-0606 5/16" x 3/8" MNPT
40-2279	FG-NPM-0806 13/32" x 3/8" MNPT
40-2280	FG-NPM-0808 13/32" x 1/2" MNPT
40-2281	FG-NPM-1008 1/2" x 1/2" MNPT
40-2282	FG-NPM-1012 1/2" x 3/4" MNPT
40-2283	FG-NPM-1212 5/8" x 3/4" MNPT



Available in steel and stainless steel through 2"

# FEMALE JIC/SAE REUSEABLE HYDRAULIC FITTING

This family of fittings is designed for 100R5 Hydraulic Hose.

NUMBER	DESCRIPTION	
--------	-------------	--

40-2266	FG-JCFX-0404 3/16" x 1/4" FJIC
40-2267	FG-JCFX-0505 1/4" x 5/16" FJIC
40-2268	FG-JCFX-0606 5/16" x 3/8" FJIC
40-2273	FG-SFFX-0606 5/16" x 3/8" FSAE
40-2269	FG-JCFX-0808 13/32" x 1/2" FJIC
40-2270	FG-JCFX-1010 1/2" x 5/8" FJIC
40-2271	FG-JCFX-1212 5/8" x 3/4" FJIC
40-2274	FG-SFFX-1212 5/8" x 3/4" FSAE
40-2272	FG-JCFX-1616 7/8" x 1" FJIC
40-2294	FG-JCFX-2020 1-1/8" x 1-1/4" FJIC
40-2295	FG-JCFX-2424 1-3/8" x 1-1/2" FJIC



Available in steel and stainless steel through 2".

# FEMALE R7 JIC ULTRA-CRIMP HYDRAULIC FITTING

This family of fittings is designed for 100R7 Thermoplastic Hose.

NUMBER	DESCRIPTION
40-2200	T7-JCFX-0404 1/4" x 1/4" FJIC
40-2201	T7-JCFX-0405 1/4" x 5/16" FJIC
40-2202	T7-JCFX-0406 1/4" x 3/8" FJIC
40-2204	T7-JCFX-0505 5/16" x 5/16" FJIC



40-2203	T7-JCFX-0506 5/16" x 3/8" FJIC
40-2205	T7-JCFX-0606 3/8" x 3/8" FJIC
40-2191	T7-JCFX-0808 1/2" x 1/2" FJIC
40-2199	T7-JCFX-1212 3/4" x 3/4" FJIC

Available in steel and stainless steel.

# FEMALE JIC R7 90° ULTRA-CRIMP HYDRAULIC FITTING

This family of fittings is designed for 100R7.

NUMBER	DESCRIPTION
40-2187	T7-JCFX90-0404 – 1/4" x 1/4" 90° FJIC
40-2189	T7-JCFX90-0505 – 5/16" x 5/16" 90° FJIC
40-2188	T7-JCFX90-0606 – 3/8" x 3/8" 90° FJIC
40-2190	T7-JCFX90-0808 – 1/2" x 1/2" 90° FJIC
40-2186	T7-JCFX90-1212 – 3/4" x 3/4" 90° FJIC



Available in steel and stainless steel.

# FEMALE JIC SAE 45° ULTRA-CRIMP HYDRAULIC FITTING

This family of fittings is designed for 100R7 Thermoplastic Hose.

NUMBER	DESCRIPTION	
40-2216	T7-SFFX-0406 1/4" x 3/8" Fem SAE	
40-2213	T7-SFFX-0506 5/16" x 3/8" Fem SAE	
40-2214	T7-SFFX-0606 3/8" x 3/8" Fem SAE	
40-2215	T7-SFFX-1212 3/4" x 3/4" Fem SAE	

Available in steel and stainless steel.

# MALE R7 JIC ULTRA-CRIMP HYDRAULIC FITTING

This family of fittings is designed for 100R7 Thermoplastic Hose.

NUMBER	DESCRIPTION	
40-2192	T7-JCM-0404 1/4" x 1/4" Male JIC	
40-2193	T7-JCM-0405 1/4" x 5/16" Male JIC	

40-2196	T7-JCM-0505 5/16" x 5/16" Male JIC
40-2195	T7-JCM-0506 5/16" x 3/8" Male JIC
40-2197	T7-JCM-0606 3/8" x 3/8" Male JIC
40-2194	T7-JCM-0808 1/2" x 1/2" Male JIC
40-2198	T7-JCM-1212 3/4" x 3/4" Male JIC



Available in steel and stainless steel.

## MALE R7 MNPT ULTRA-CRIMP HYDRAULIC FITTING

This family of fittings is designed for 100R7 Thermoplastic Hose.

NUMBER	DESCRIPTION
40-2211	T7-NPM-0402 1/4" x 1/8" Male NPT
40-2212	T7-NPM-0404 1/4" x 1/4" Male NPT
40-2207	T7-NPM-0504 5/16" x 1/4" Male NPT
40-2208	T7-NPM-0604 3/8" x 1/4" Male NPT
40-2206	T7-NPM-0606 3/8" x 3/8" Male NPT
40-2210	T7-NPM-0808 1/2" x 1/2" Male NPT
40-2209	T7-NPM-1212 3/4" x 3/4" Male NPT



Available in steel and stainless steel.

# AC FERRULES FOR UNI-CRIMP AC HOSE

This family of fittings is designed for 4826 AC Hose.

NUMBER	DESCRIPTION	
40-2171	-6 AC Ferrule	
40-2172	-8 AC Ferrule	
40-2173	-10 AC Ferrule	
40-2174	-12 AC Ferrule	